

Dec. 1953

INSTRUCTION AND OPERATING MANUAL
FOR

MODEL 608A
VHF SIGNAL GENERATOR
Serial 1360 and Above

HEWLETT-PACKARD COMPANY
395 PAGE MILL ROAD, PALO ALTO, CALIFORNIA, U.S.A.

General Description

The Model 608A Signal Generator is a general purpose laboratory generator covering the 10 to 500 megacycle band. Both the frequency and output are calibrated. Internal modulation at either of two fixed frequencies is provided. The instrument may also be modulated from external sources of sine waves or pulses.

The Model 608A may be used for measuring gain, selectivity or image rejection of receivers, IF and broad band amplifiers. The high output voltage (1 volt into a 50 ohms load) of the generator is suitable for driving bridges, slotted lines, transmission lines, antennas, and filter networks.

Parts Substitutions

Difficulties in procuring some of the parts used in this instrument may cause the electrical or physical values to deviate from those shown in this instruction manual. These substitutions have been made so as not to impair the performance of this instrument. Whenever replacement of any of these parts is necessary, either the substitute value or the original value may be used.

CAUTION

DO NOT APPLY ANY EXTERNAL VOLTAGE TO THE OUTPUT TERMINAL OF THIS INSTRUMENT.

CAUTION

Replacement of Electrolytic Capacitors

The electrolytic capacitors in this instrument are very high quality capacitors which have a useful life of from five to ten years. Do not replace these capacitors unless they are proven defective by accurate tests.

INSTRUCTIONS
MODEL 608A
VHF SIGNAL GENERATOR

Specifications

Frequency Range --

10 to 500 megacycles in 5 ranges.
Ranges - 10-21 mc, 21-45 mc, 45-100 mc, 100-230 mc, 230-500 mc.

Calibration Accuracy --

Within $\pm 1\%$. Frequency settings can be duplicated within $.2\%$.

Output Voltage ---

.1 microvolt to 1.0 volt, continuously variable; Direct Reading controls calibrated in voltage and dbm.

Rated Load Impedance --

50 ohms resistive

Internal Impedance --

50 ohms; maximum VSWR 1.2

Output Voltage Accuracy --

Within ± 1 db in rated load over entire frequency range.

A-M Modulation --

Internal or external; continuously variable from 0 to 90% as indicated by Percentage Modulation Meter.

Internal Modulation --

Two fixed modulating frequencies, 400 and 1000 cps.

Envelope Distortion --

Approximately 2.5% at 30% modulation at most frequencies

External Modulation --

Modulation from 0 to 90% may be obtained with a 4 volt input across 15,000 ohms. Modulating frequency range for all bands 20 to 100,000 cycles/second and for all output frequencies of 100 megacycles and above, (Bands D and E), modulating frequencies of up to 1 megacycle will produce 30% modulation.

Pulse Modulation --

By pulses of at least 10 volts positive amplitude from average level. Pulse widths from 1 to 30 μ seconds may be used. Good one μ second pulse output may be obtained on operating frequencies of 100 megacycles and above.

Leakage --

Negligible; permits receiver sensitivity measurements down to at least .1 microvolt.

Residual FM --

Not more than .0025% at 30% modulation.

Power Supply Rating --

Voltage - 115/230 volts \pm 10%
Frequency - 50-60 cycles/sec.
Wattage - 150 watts

Cable Supplied --

1 - Three conductor rubber covered cable 7-1/2 feet long. Motor base plug on end, standard two prong plug on other end, with third wire projecting from both ends.*

Panel Connectors -

RF OUTPUT - type N jack
PULSE INPUT - type BNC jack
EXT. MOD. - Hewlett-Packard binding posts spaced 3/4"

Overall Dimensions --

12" wide x 15" high x 20-1/4" deep

Weight --

55 pounds

* The Output Cable is not supplied with the instrument, but may be purchased as an accessory. See "Replaceable Parts List."

Operating Instructions

Inspection --

This instrument has been thoroughly tested and inspected before being shipped. It is ready for use when you receive it. It should be looked over carefully for any signs of damage during shipment. The unit may be turned on and operated in accordance with the instructions which follow. If any damage or evidence of unsatisfactory operation is found, follow the procedure outlined in the "Claim for Damage in Shipment" page at the back of the instruction book.

Controls and Terminals --

TRIMMER - Just above the output level control is the trimmer control. This control adjusts the tuning of the power amplifier. Although the main tuning of the power amplifier is tracked with the oscillator and adjusted by means of the main frequency dial, perfect tracking is not possible and so this trimmer adjustment is provided to peak the output and thus make sure the amplifier tank circuit is accurately tuned to the oscillator frequency.

Frequency Control - The frequency control dial is located on the upper right section of the panel. This is a large knob with a crank handle and with a uniformly calibrated dial for interpolation purposes. Just above the frequency control is the main dial. The frequency control knob drives the variable capacitors in the master oscillator and power amplifier together and, at the same time, turns the main dial which indicates the output frequency directly in megacycles. A small pointer at the left side of the main dial window is provided to indicate which scale to read. The position of this indicator moves in accordance with the position of the RANGE control knob.

OUTPUT LEVEL - The output level control, located at the center of the front panel, adjusts the level of the CW output. Adjustment of this control should vary the reading of the output voltmeter. The large knob is used for coarse adjustment of the output voltage while the small knob is for fine adjustment.

CW, PULSE 400 μ , 1000 μ , EXT. MOD. - In the center of the panel on the right side is a switch which selects the modulation functions for the generator. In the top position, the generator delivers a CW output without modulation. The second position down connects the PULSE INPUT jack to the generator so the generator may be modulated from an external pulse. The next position connects a 400 cycle internal oscillator to modulate the generator. The next position connects a 1000 cycle generator to the oscillator for the same function. The lowest position connects the EXT. MOD. terminals to modulate the generator from an external source. All positions except PULSE and CW are controlled by MOD. LEVEL control.

MOD. LEVEL - At the lower left hand side of the control panel is a control which adjusts the percentage of modulation of the generator. This adjusts the modulating voltage supplied to the power amplifier and it will vary the reading of the percent modulation meter. It will operate only when the function selector switch is in the 400 cycles or 1000 cycles position, or in the external modulation position and an external signal is applied to the generator.

RANGE - The knob which selects the frequency range is on the lower left side of the control panel. This knob drives the turrets for the oscillator and power amplifier. The ranges are lettered from A through E. The proper range to select can be determined by looking at the panel markings by the main frequency dial.

ATTENUATOR - The attenuator dial is located in the lower right hand section of the control panel. This control is used to adjust the output level a known amount below the level indicated by the output voltmeter. The dial is calibrated in millivolts, microvolts, and decibels. The decibel scale indicates the number of decibels below 1 milliwatt.

POWER - The power switch is located below the modulation function selector and controls all power supplied to the instrument from the power line. The ON position is marked on the panel and a pilot light behind the main dial should light up when the switch is turned to the ON position.

FUSE - Just below the power switch is a fuseholder which contains a 3 ampere cartridge fuse. The fuse may be replaced by unscrewing the fuseholder cap and inserting a new fuse. Use a 1.5 ampere fuse for 230V operation.

FUSE - The fuse for the high voltage direct current is contained in a fuseholder which is reached through a hole in the rear of the instrument case. This access hole is covered by a plug button.

The fuseholder contains a 1/16 ampere cartridge fuse. The fuse may be replaced by unscrewing the fuseholder cap and inserting a new fuse. Always turn off the POWER switch before inserting a new 1/16 ampere fuse in the fuseholder; otherwise the initial overload will cause the fuse to blow when it is inserted.

Power Input - A motor base socket is provided at the lower left corner of the panel to connect the power cord to the instrument. The instrument is shipped from the factory with the power transformers connected for 115V operation. If it is necessary to operate the instrument from a 230 volts supply, see the Maintenance Section for changing transformer connections.

EXT. MOD. - Connections for external modulation consists of two -hp-binding posts on the lower left side of the panel. These terminals are to connect an external source of modulating voltage to the generator.

PULSE INPUT - The pulse input terminal is a type BNC jack located at the bottom center of the panel. This connection is to connect an external pulse source to modulate the generator.

OUTPUT - This type N jack, located at the lower right hand corner of the control panel, is the output terminal for the radio frequency voltage generated by the instrument.

Auxiliary Equipment Required --

The Model 608A VHF Signal Generator may be operated without any auxiliary equipment except a source of 115 volts or 230 volts, 50-60 cycles power. When a pulse output is desired it is necessary to connect a pulse generator to the Model 608A. The pulse generator used should be capable of generating positive pulses of at least 10 volt peak amplitude into an impedance of 100,000 ohms. The Hewlett-Packard Model 212A Pulse Generator is recommended for this application. If amplitude modulation other than 400 or 1000 cycles is desired, it is necessary to have an audio oscillator or other source of external modulation available. Any one of the Hewlett-Packard 200 series audio oscillators is suitable for this application.

Operating Procedure --

1. Connect the OUTPUT terminal of the Model 608A to the equipment to be driven, preferably by means of a 50 ohm coaxial cable.
2. Connect the power cable to a source of 115 volts or 230 volts (See Maintenance Section) 50/60 cycles current, and turn the POWER switch to ON. The equipment will operate after warm-up time of a minute or so although it is preferable to allow 10 or 15 minutes warm-up for the output frequency and level to stabilize.
3. Set the RANGE control to the desired frequency range.
4. Rotate the frequency control until the desired frequency is indicated by the frequency dial.
5. Adjust the OUTPUT LEVEL control until a reading is obtained on the output voltmeter. It is preferable not to bring this level up to a full scale reading on the meter, at first.
6. Adjust the TRIMMER knob for a maximum reading on the output voltmeter.

7. Set the OUTPUT LEVEL control to give the desired reading on the output voltmeter and adjust the ATTENUATOR control to give the desired final output level.

a. With the ATTENUATOR knob turned to the full clockwise position so its dial reads 500 millivolts, the output voltage of the generator is read directly in volts on the output meter when the output cable is terminated by 50 ohms.

b. When the output meter is adjusted to the SET LEVEL point, the output voltage can be read directly from the ATTENUATOR dial, again provided that the cable is terminated in 50 ohms.

c. In either case, the output level will vary with the termination on the output cable. When the output cable is open circuited, or when it has an impedance very high in respect to 50 ohms, the voltage at the end of the output cable will be approximately twice the voltage indicated by either of the two conditions above.

d. When the output cable is terminated in an impedance other than 50 ohms the output voltage at the end of the cable may be calculated by considering that the output circuit is equivalent to a generator having twice the voltage indicated by the meter or the attenuator dial, as the case may be, and having a source impedance of 50 ohms.

e. The output of this generator has been adjusted to be most accurate when the ATTENUATOR dial is set at zero db or lower and when the output level meter is at the SET LEVEL point. In this case, the output voltage as a function of frequency should be within a few-tenths of a db of the values indicated by the meter and the dial. Comparable accuracy should be obtained for attenuator settings below zero dbm. When the ATTENUATOR dial is in the maximum position, the output voltage, as a function of frequency, should be within $\pm 1/2$ db of the voltage indicated by the output level meter.

8. The percent modulation meter is calibrated to read correct only when the OUTPUT VOLTS meter is first adjusted to the SET LEVEL point before any modulation is applied to the unit. The unit may be modulated with the OUTPUT VOLTS above the SET LEVEL point, but for best modulation and for a correct reading of the modulation meter, the OUTPUT VOLTS meter must be adjusted to the SET LEVEL point. The procedure is as follows:

a. Adjust the TRIMMER control to make sure the output level is maximized.

b. By means of the OUTPUT LEVEL control, adjust the output voltmeter to the SET LEVEL point.

c. By means of the MODULATION LEVEL control adjust the modulation until the modulation meter reads the desired PERCENT MODULATION.

9. Pulse Operation - For pulse operation the generator is first adjusted to the desired CW level with the selector switch in the CW position. The selector switch is then turned to the PULSE position and the desired pulse voltage is applied to the input terminal. This will provide a peak pulse level equal to the CW level which was previously set, provided the input voltage is high enough to completely cut off the pulse tube. Because the power amplifier is modulated by the pulses and because there is a certain amount of feed-thru when the power amplifier is cut off, the level between pulses is not completely zero. The ratio of levels between the pulse on and pulse off positions will vary with frequency. At lower frequencies it will be in the order of 40 db. At higher frequencies there may be some conditions for which the off level will be only about 20 db below the pulse level.

10. There are many frequencies at which the output voltmeter can be made to go off scale by means of the OUTPUT LEVEL control. When CW outputs larger than 1 volt are desired, no harm can be done by operating the generator with the OUTPUT LEVEL control wide open, in which case the output level meter will read off scale. It is, however, not possible to get satisfactory modulation under these conditions.

11. It is not possible to get good pulse modulations with short pulses when the carrier frequency is less than 100 megacycles. Reasonably good pulse envelopes can be obtained at 100 megacycles and above with pulses 1 microsecond in length or more. Below 100 megacycles, and especially as 10 megacycles is approached, the tuned circuits cut the side band sufficiently so that the time-of-rise and the time-of-decay may be each in the order of a microsecond or more.

Only positive pulses should be applied to the PULSE INPUT jack. Negative pulses may be applied to the EXT. MOD. terminals. However, the carrier voltage will be reduced to approximately zero for the duration of each negative pulse.

The pulse shape at low frequencies may be improved by connecting a 5600 ohms composition resistor across the tuning capacitor (C5) in the amplifier section. The procedure for installing this resistor is as follows:

1. Remove the instrument from its cabinet.
2. Remove the cover plate from the left side (as you face the instrument) of the oscillator-amplifier shield box.
3. Solder a 5600 ohms composition resistor between the two stator sections of the variable capacitor C5 as shown in figure 7.

Circuit Description

The Model 608A Signal Generator uses a master oscillator-power amplifier circuit to cover the frequency range from 10 to 500 megacycles. Figure 1 shows a block diagram of the Model 608A circuit. The master oscillator and tuned amplifier both use RCA "pencil" triodes. These circuits are tuned by variable capacitors ganged together. Ranges are changed by rotating turrets which successively place the proper oscillator and power amplifier coils in operating position. Although the two tuned circuits are ganged and operated by the main frequency control, a trimmer is provided to independently tune the power amplifier over a small frequency range. This is necessary when good modulation characteristics are desired.

The master oscillator operates at a constant level and the output level is adjusted by adjusting the voltage bias on the amplifier. The bias is applied to the cathode of the amplifier as is the modulating voltage when modulation is desired.

The output attenuator is a piston type attenuator coupled directly into the coil of the amplifier. Monitor circuits are provided to measure the field intensity in the attenuator tube and thus enable the operator to set the proper output level by means of an indicating meter. These monitor circuits are also used to measure and set the percent modulation.

The output attenuator is a constant impedance network designed to provide a source impedance of 50 ohms over the entire frequency range of the generator. The output voltage is determined by the setting of the output level meter and the attenuator, and the calibration is arranged so the output voltage is indicated correctly when the output is terminated with a 50 ohm load. Since the source impedance of the attenuator is very close to 50 ohms, the open circuit voltage of the generator is approximately twice the voltage indicated by the setting of the output controls over the entire frequency range.

A regulated power supply provides voltages for the various tubes in the unit. 400 and 1000 cycle audio oscillator is provided in this generator to give modulation at these frequencies without auxiliary equipment. Facilities are provided for connecting an external sine wave source or an external pulse source to modulate the generator.

Maintenance

Generally, little or no maintenance should be required other than replacement of tubes, from time to time, as they may wear out.

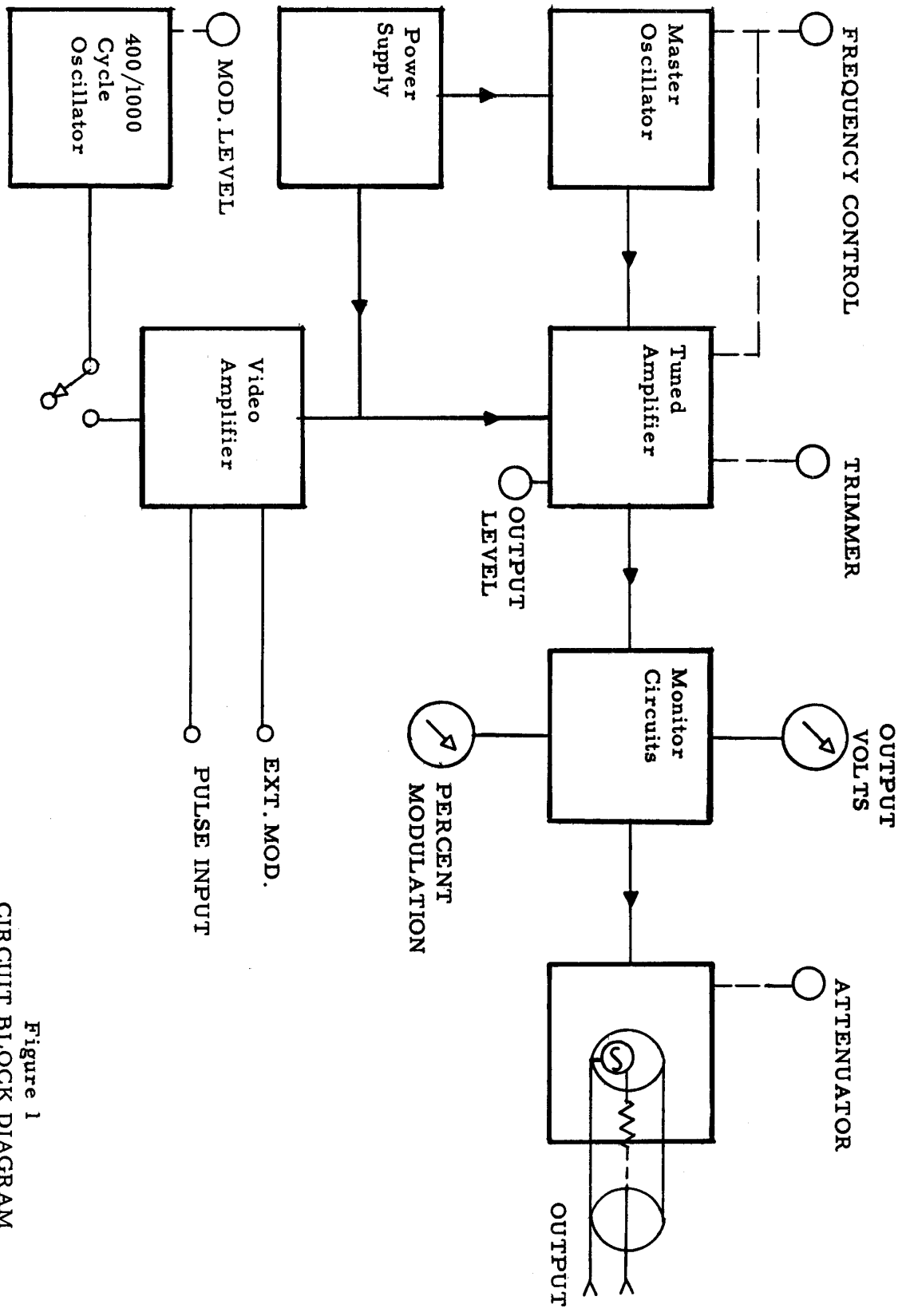

Figure 1
CIRCUIT BLOCK DIAGRAM

Cabinet Removal --

To remove the unit from its case, remove the four screws from the rear of the cabinet. With these screws loosened, the entire unit will slide forward out of its cabinet. Tubes and other components are then accessible for servicing and inspection.

5893*, 5876 Tube Replacement --

To inspect or replace the pencil triodes used in the oscillator and power amplifier, the procedure is as follows: (both tubes)

1. Remove all of the screws (#1) from the cover plate, as shown in figure 3. Lift this cover plate from the main casting.
2. Unsolder the cathode heater leads from the tubes, as shown in figure 4.

Oscillator Tube (V1) -

1. Unscrew the three screws (2, fig. 4) from the oscillator tube socket and remove the socket.
2. The oscillator tube may now be lifted vertically from the socket which holds it in place. It should slide up easily.

Amplifier Tube (V2) -

1. Before the power amplifier tube can be removed, the clip, which is the connection from the coupling cable, must be slid carefully off the cathode cylinder, as shown in figures 4, 5.
2. Remove the two screws (3, fig. 4) from the amplifier tube spring plate and lift out the plate and spring (figures 4, 6).
3. The amplifier tube may now be lifted vertically from the hole in the casting.

Re-assembly of Oscillator Tube (V1) -

1. Insert the 5893 tube in plate contact (fig. 5) lead end up.
2. Slip the oscillator tube socket, with the spring down, over the lead end of the tube (fig. 6).

*All references to the type 5893 tube also apply to the type 5675 tube.

3. Replace the 3 screws (#2, fig. 4) that fasten the socket to the casting. Fasten the heater lead solder lug under one screw.

Amplifier Tube (V2) -

1. Insert the 5893 tube in the hole in the casting (fig. 5) lead end up.
2. Slide spring and spring plate over the lead end of the tube (fig. 6).
3. Replace the two screws (3, fig. 4) that fasten the spring plate to the casting.

Both Tubes -

1. Solder heater leads to the leads on the ends of the tubes.
2. Replace the cover plate and fasten in place.

Lubrication --

All the accessible bearings on the frequency dial drive, trimmer and attenuator drive shaft should be lubricated every 3 to 6 months depending on how frequently the instrument is used. One or two drops of Lubriplate #2 manufactured by the Fiske Brothers Refining Co., Newark, New Jersey, should be used. Lubrication points marked "X" are shown in Figure 2A.

Output Level Checking --

The output level may be checked, from time to time, if there is any evidence that it is in error. It is preferable to use a bolometer bridge. The combination of Hewlett-Packard Model 430A and the Model 476A Bolometer Mount may be used to check the output level at the higher end of the frequency range. Generally it is satisfactory to check the level at one or two points because it is unlikely that the variation in output levels with frequency will change over a period of time, although it is possible that the absolute output level should be checked occasionally.

Power Transformer Connections --

This instrument is shipped from the factory with the power transformer primaries connected in parallel for 115V operation. If 230V operation is desired, the primaries will have to be connected in series as shown in the "Transformer Detail".

SCHEMATIC DIAGRAM OF MODEL 608A SERIAL 1302 & ABOVE

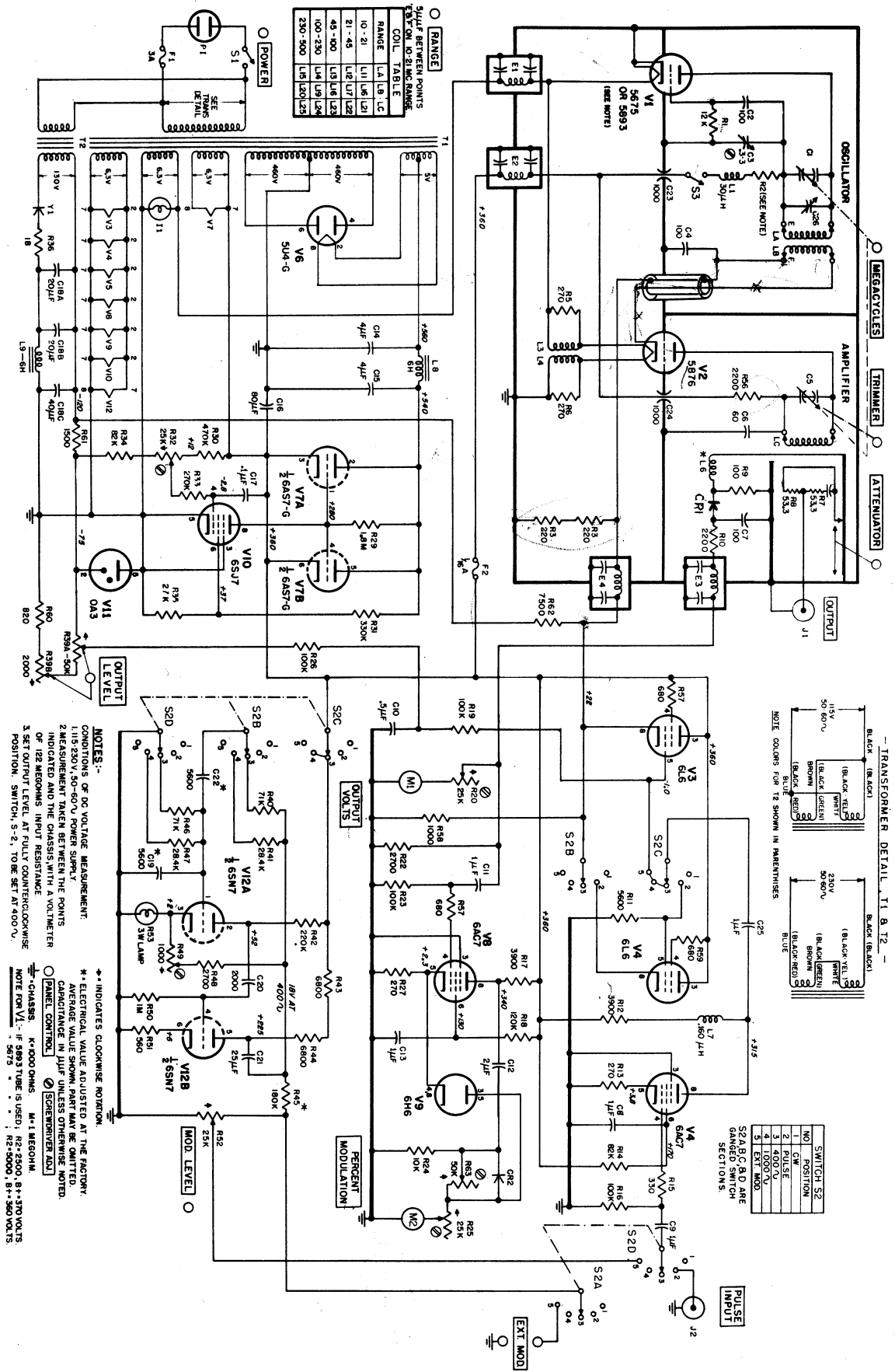

COIL TABLE

RANGE	LA	LB	LC
10 - 21	L1	L6	L21
21 - 45	L2	L7	L22
45 - 100	L3	L8	L23
100 - 230	L4	L9	L24
230 - 500	L5	L10	L25

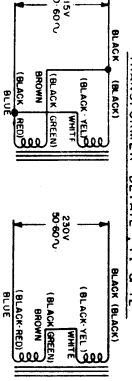

SWITCH S2 POSITION

NO.	POSITION
1	CW
2	PULSE
3	400V
4	EXT MOD.
5	EXT MOD.

- NOTES:-**
- CONDITIONS OF DC VOLTAGE MEASUREMENT: 1.15-230V, 50-60V POWER SUPPLY.
 - MEASUREMENT TAKEN BETWEEN THE POINTS INDICATED AND THE CHASSIS, WITH A VOLTMETER OF 12K MEGOHMS INPUT RESISTANCE.
 - SET OUTPUT LEVEL AT FULLY COUNTERCLOCKWISE POSITION. SWITCH, S-2, TO BE SET AT 400V.
- * INDICATES CLOCKWISE ROTATION.
 * ELECTRICAL VALUE ADJUSTED AT THE FACTORY. AVERAGE VALUE SHOWN PART MAY BE OMITTED. CAPACITANCE IN μ F UNLESS OTHERWISE NOTED.
 * CHASSIS: K=1000 OHMS, M=1 MEGOHM.
 NOTE FOR V1: IF 5083 TUBE IS USED: R2=2500, R1=370 VOLTS, R3=5000, R4=350 VOLTS.

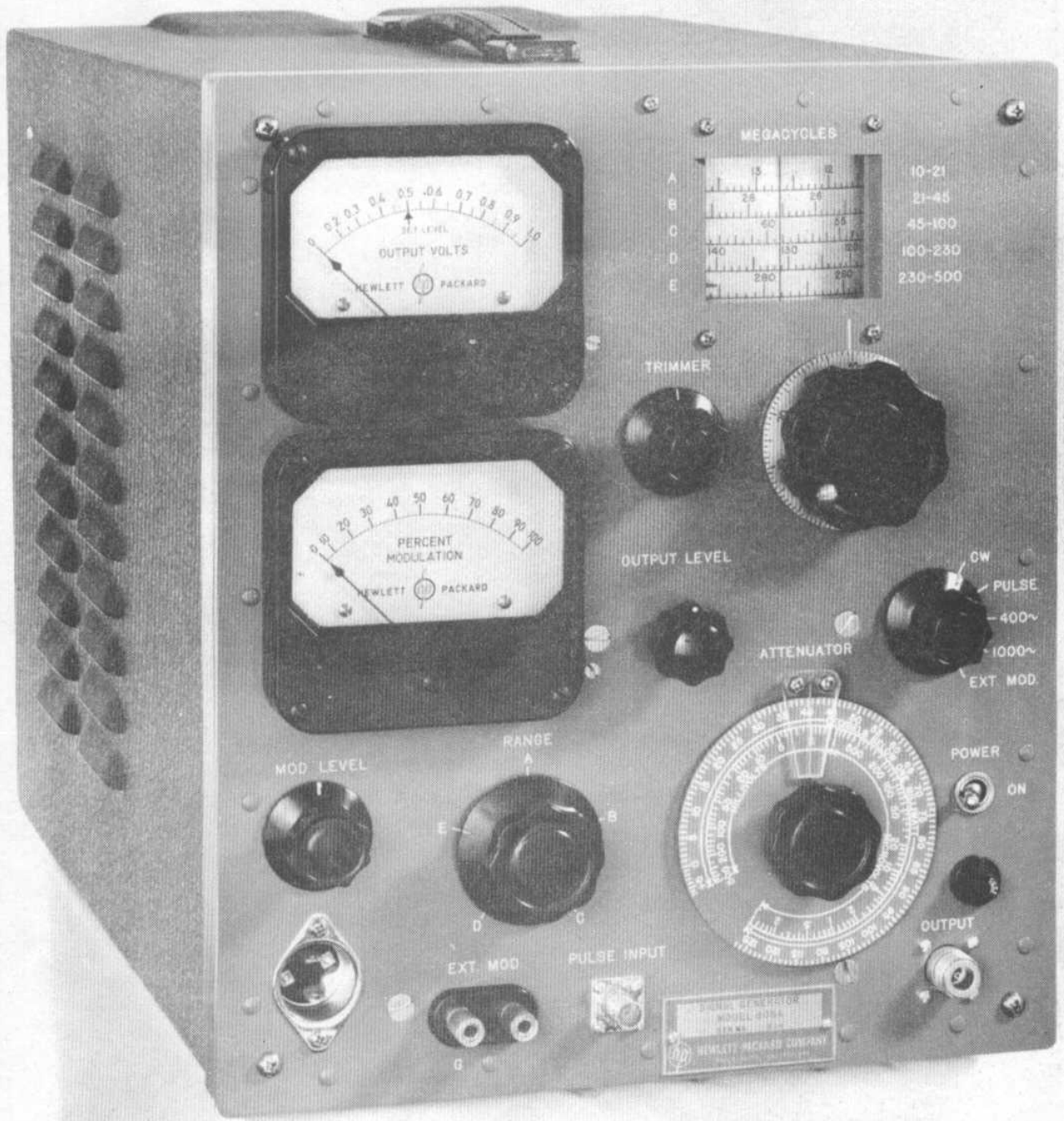

Fig. 2. Model 608A

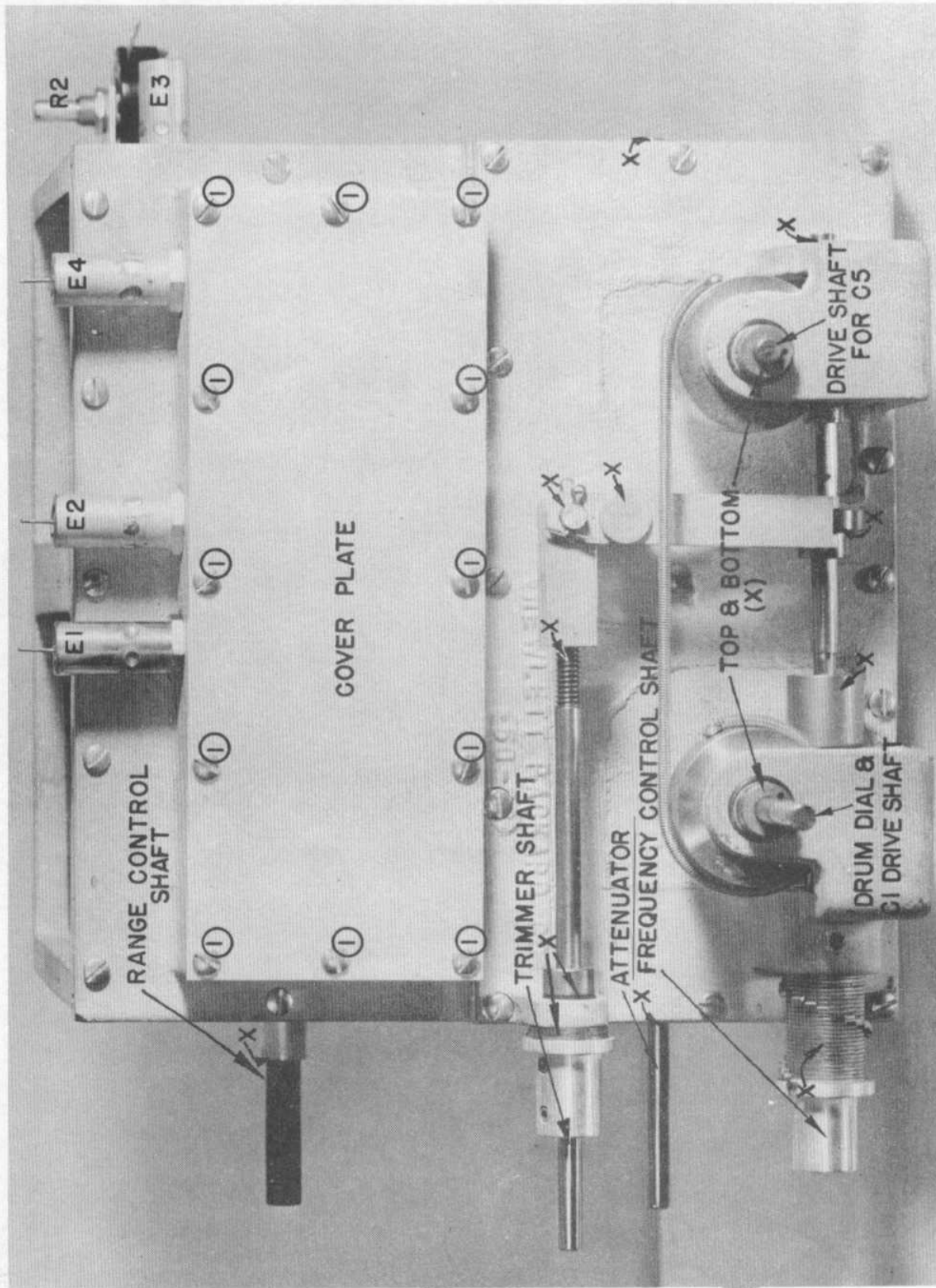

Fig. 3. Top View of Tuner Casting

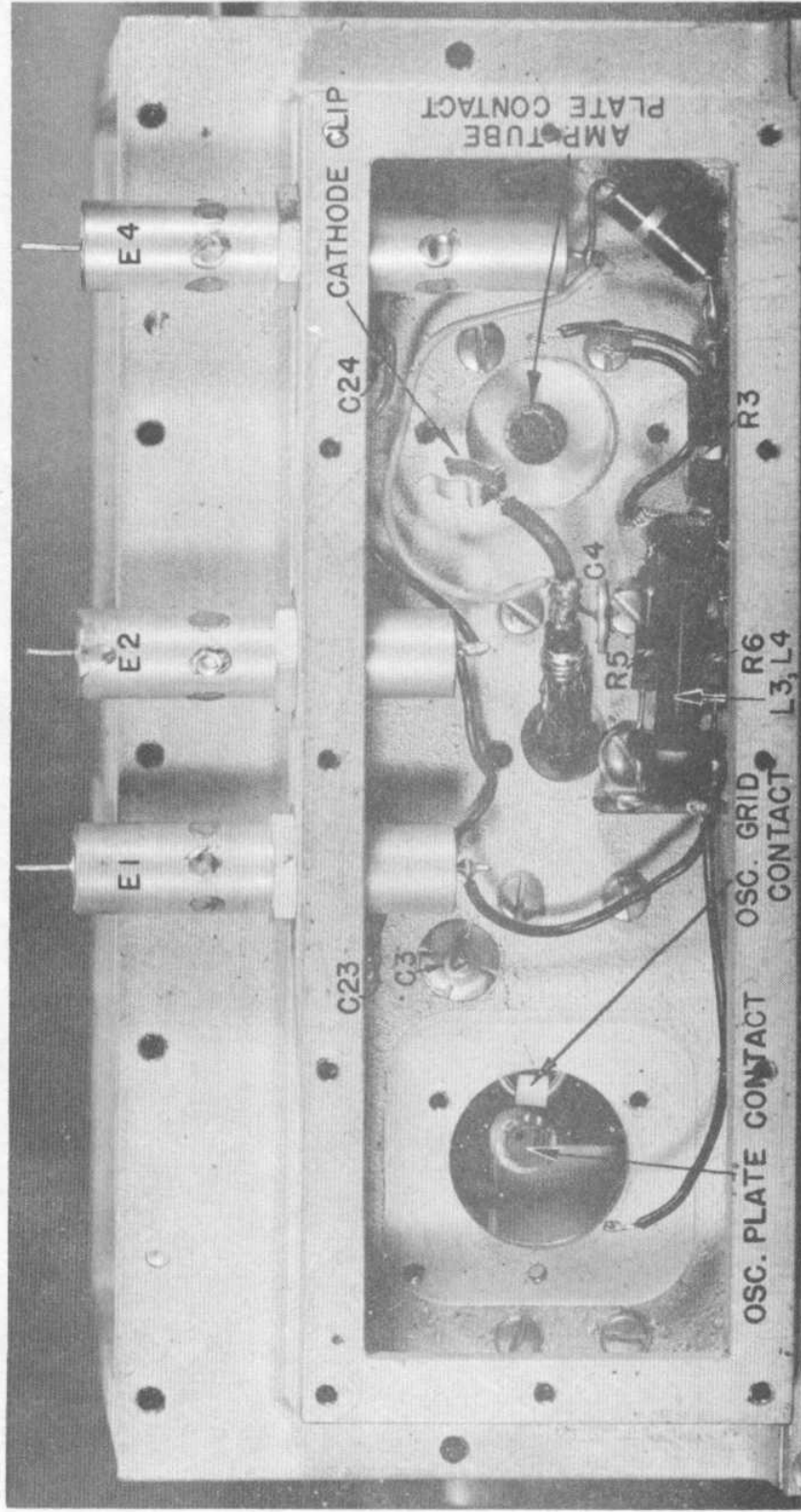

Fig. 5. Tuner Casting Cover Plate and Tubes Removed To Show Tube Socket Details.

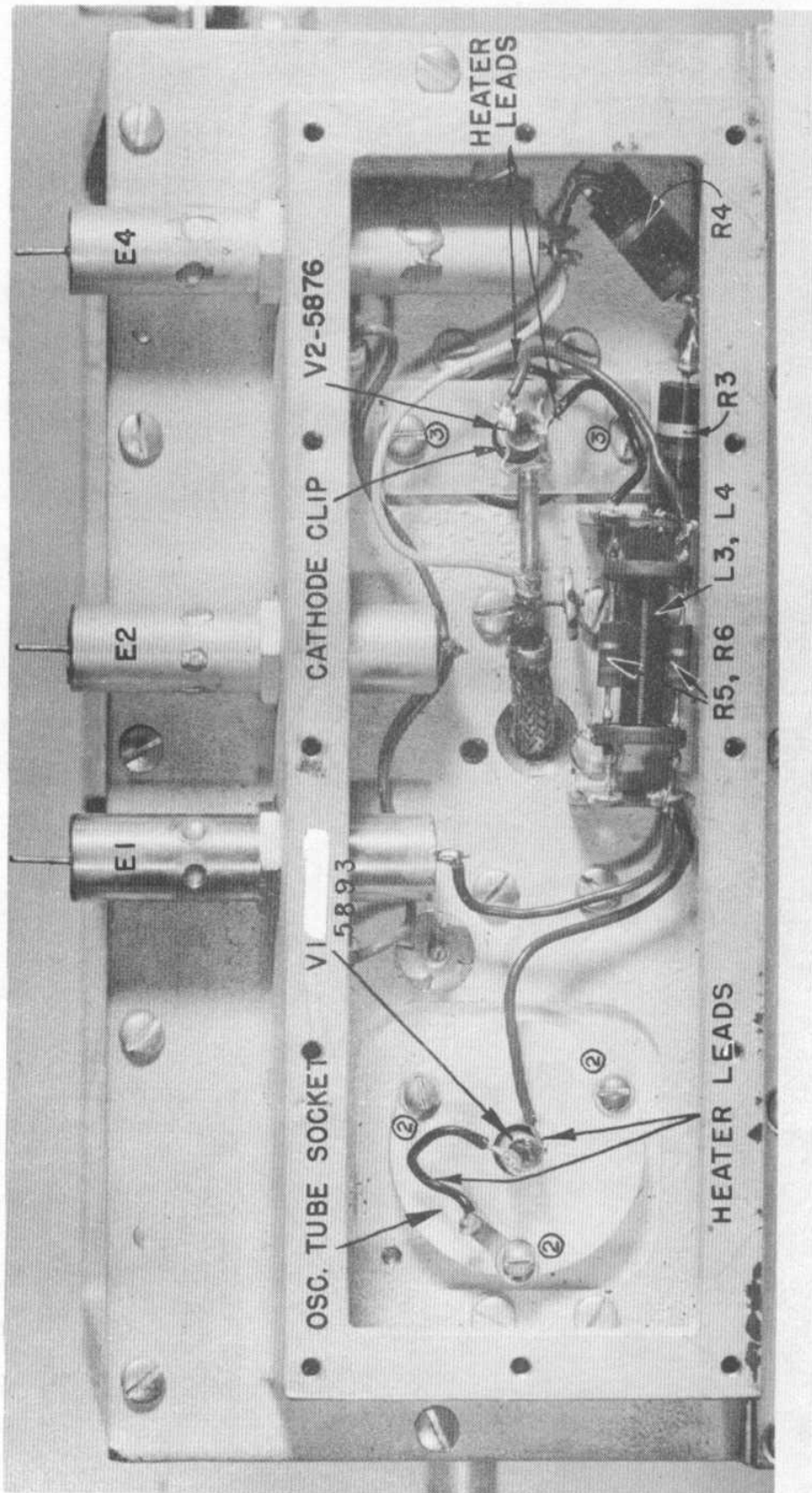

Fig. 4. Tuner Casting Cover Plate Removed To Show Tube Socket Connections

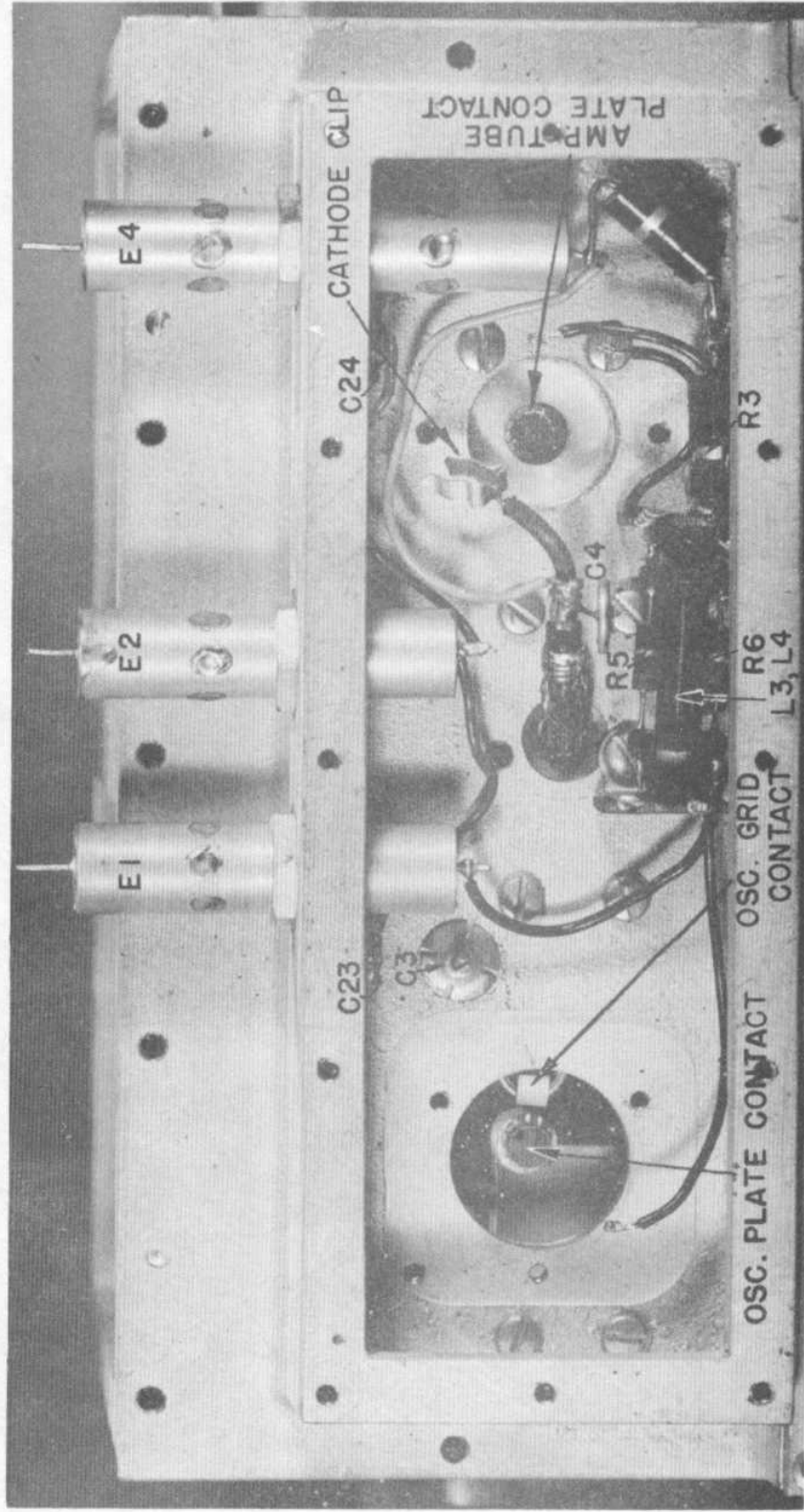

Fig. 5. Tuner Casting Cover Plate and Tubes Removed To Show Tube Socket Details.

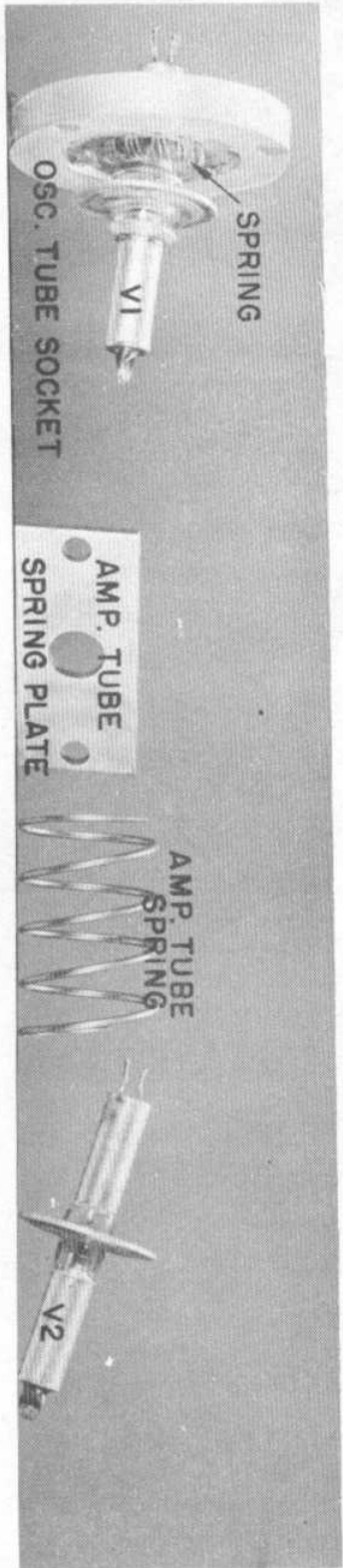

Fig. 6. Oscillator and Amplifier Tube Socket Parts

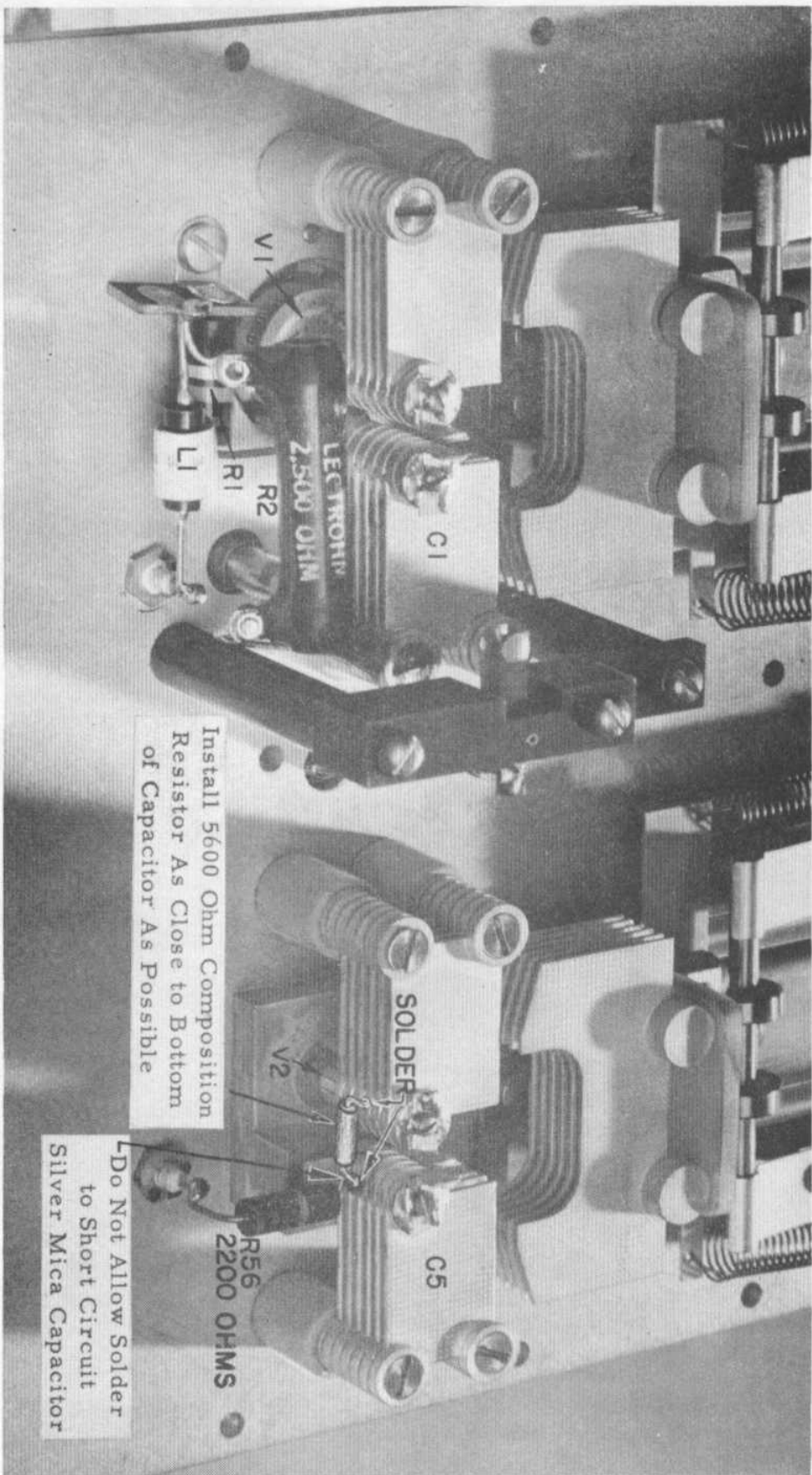

Fig. 7. Tuning Capacitors

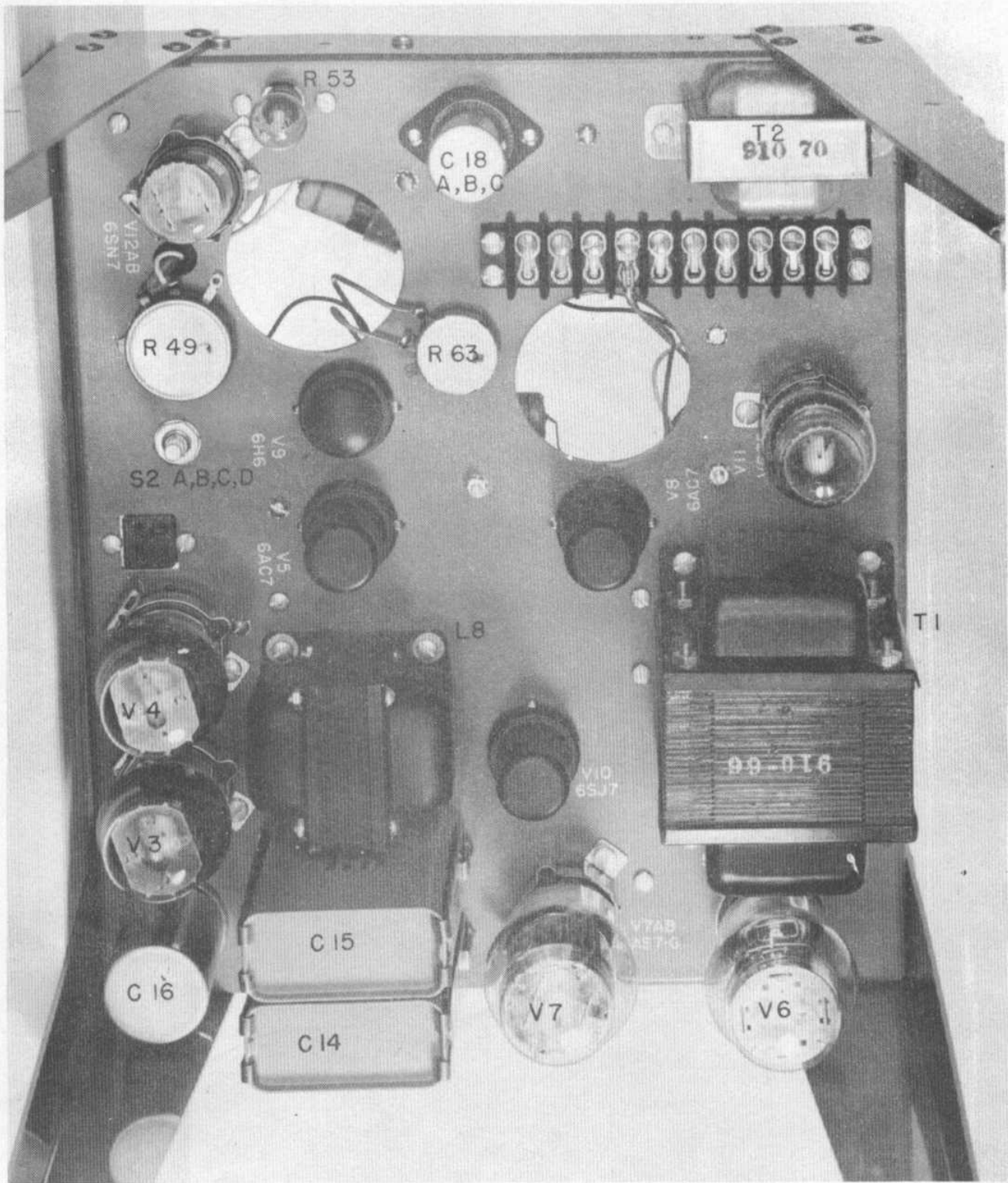

Fig. 8. Model 608A Front View of Chass Case Removed

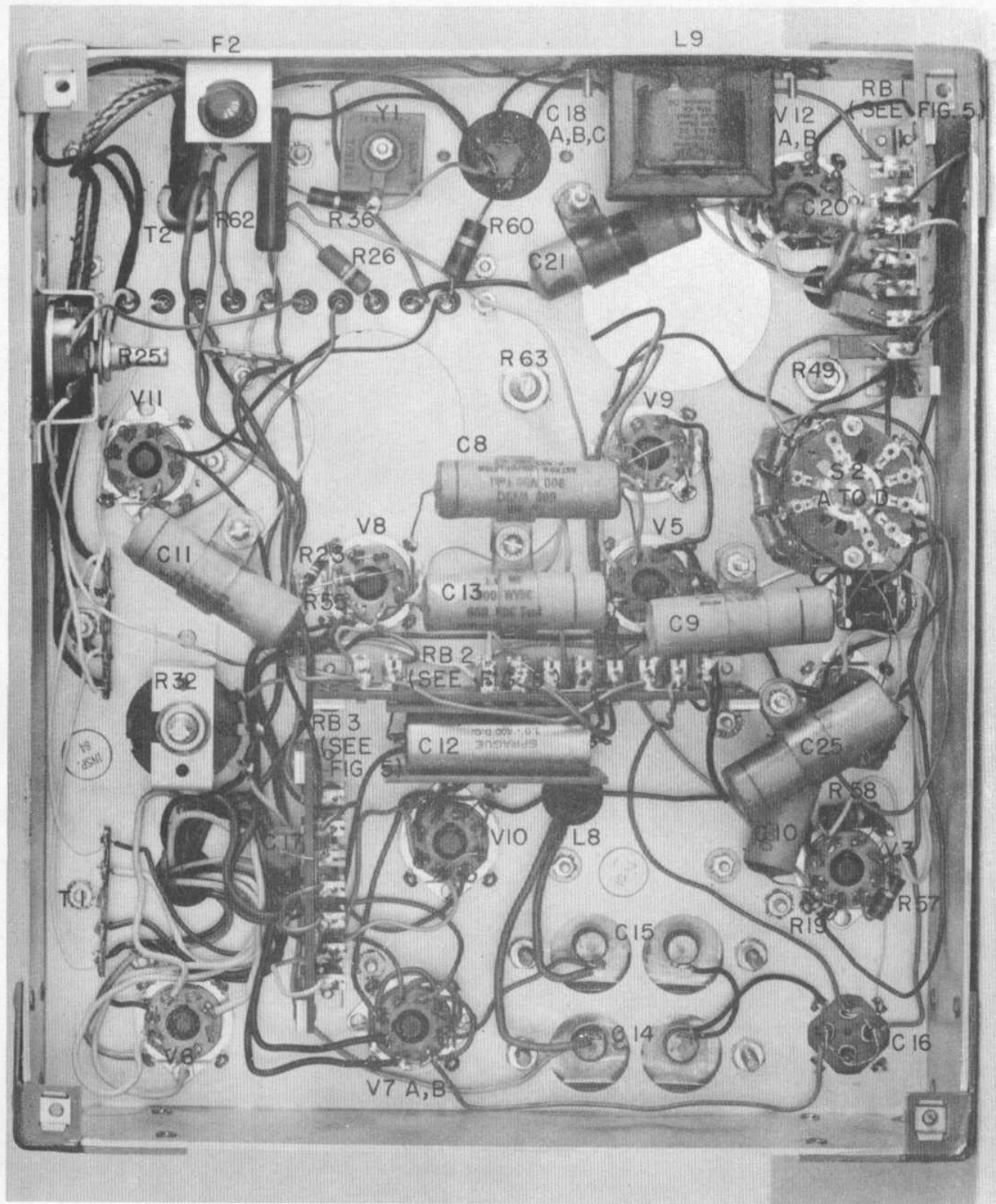

Fig. 9. Model 608A Rear View of Chassis Case Removed

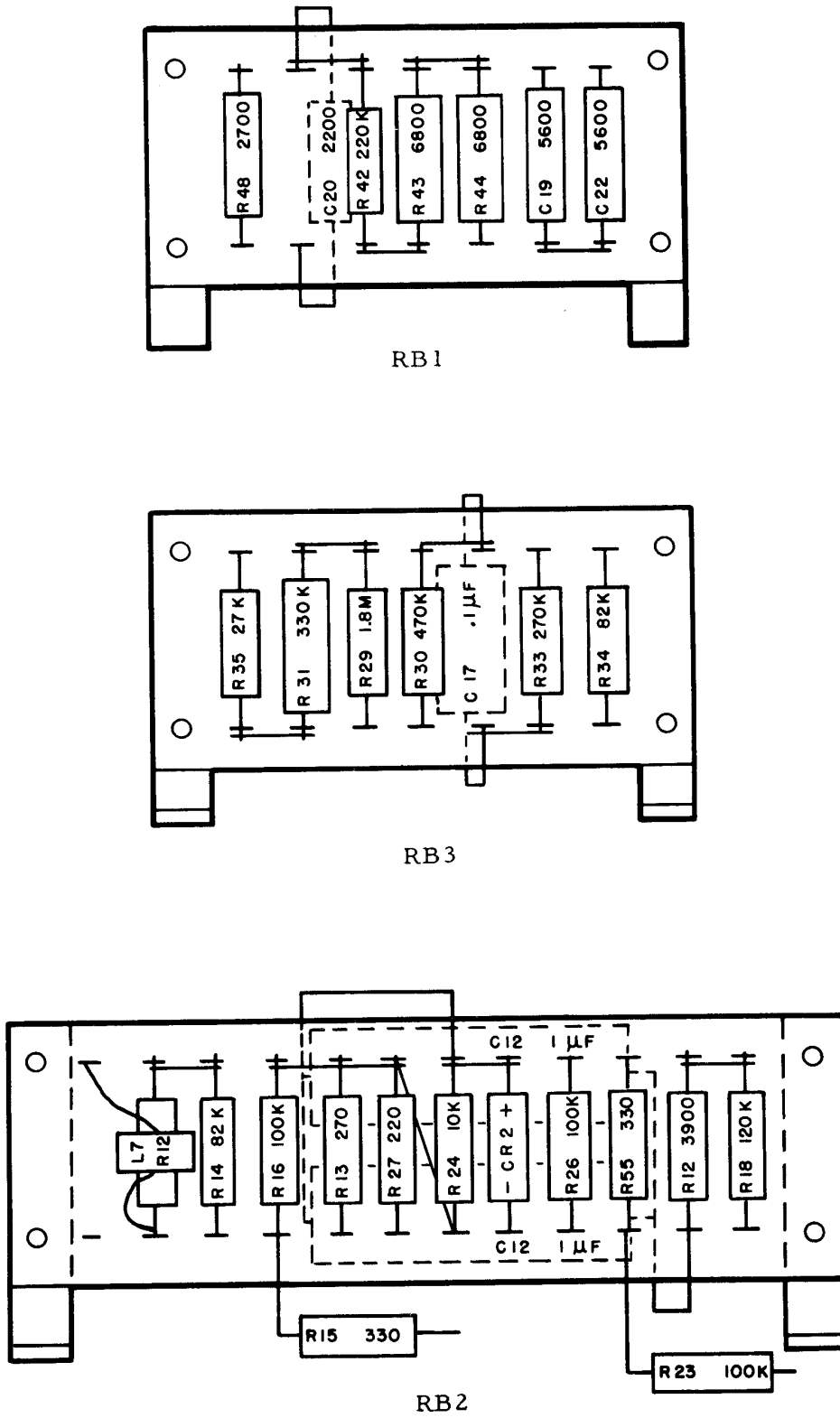
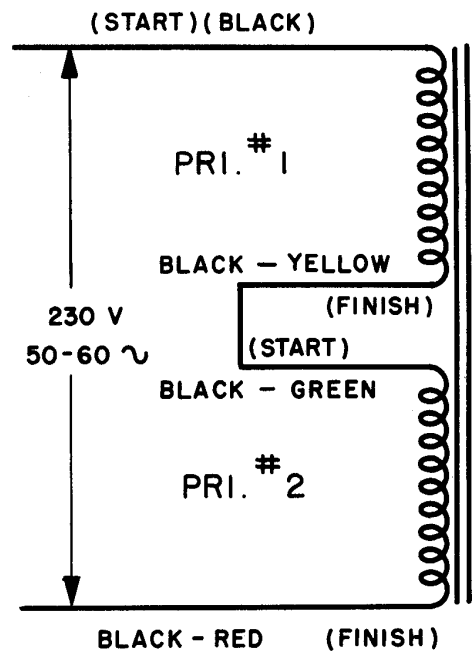
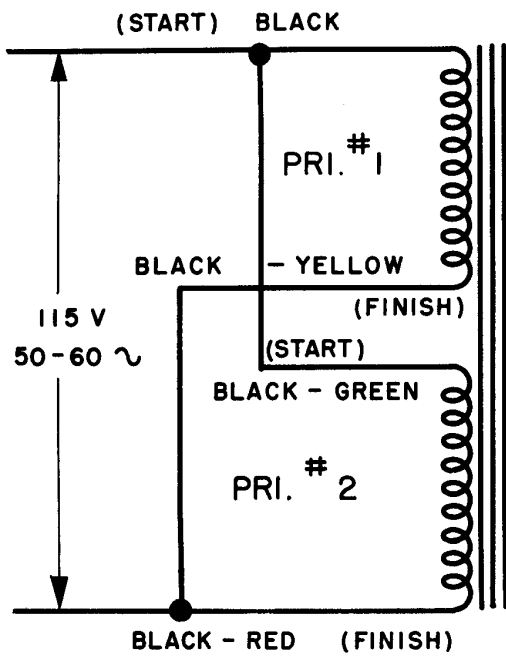

Fig. 10. Resistor Board Details



TRANSFORMER DETAIL

PRODUCTION CHANGE

Serial 1302 and above

Replaceable Parts List --

Add Switch S3:

Switch: SPDT, HP Stock #310-47, Mfr. Micro-Switch
Div. of Minneapolis-Honeywell Regulator Co, BZ-2RS

608A 6/10/53 Serial 1302 and above

PRODUCTION CHANGE

Serial 1360 and above

Replaceable Parts List --

Change C12 to:

Capacitor: fixed, paper, 2.2 μ f, $\pm 10\%$, 400 vdcw,
HP Stock #16-63, Mfr. CC, 88P-S4

608A - 7/10/53 Serial 1360 to

TABLE OF REPLACEABLE PARTS

Circuit Ref.	Description	-hp- Stock No.	Mfr. * & Mfrs. Designation
R1	Resistor: fixed, composition, 12,000 ohms, ±10%, 1/2W	23-12K	B EB 1231
R2	Resistor: fixed, wirewound, 25,000 ohms, ±10%, 10W	26-7	S Type 1-3/4E
or R2	Resistor: fixed, wirewound, 5000 ohms, ±10%, 10W	26-8	S Type 1-3/4E
R3	Resistor: fixed, composition, 220 ohms, ±10%, 2W	25-220	B HB 2211
R4	Resistor: fixed, composition, 220 ohms, ±10%, 2W	25-220	B HB 2211
R5	Resistor: fixed, composition, 270 ohms, ±10%, 1/2W, Part of L3		
R6	Resistor: fixed, composition, 270 ohms, ±10%, 1/2W, Part of L4		
R7	Resistor: fixed, composition, 47 ohms, ±10%, 1/4W	22-11	F, Global Div. Type CX
R8	Resistor: fixed, composition, 47 ohms, ±10%, 1/5W	21-47	F, Global Div. Type 997A
R9	Resistor: fixed, composition, 100 ohms, ±10%, 1/5W	21-100	F, Global Div. Type 997A
R10	Resistor: fixed, composition, 2200 ohms, ±10%, 1W	24-2200	B GB 2221
R11	Resistor: fixed, composition, 5600 ohms, ±10%, 1W	24-5600	B GB 5621
R12	Resistor: fixed, composition, 3900 ohms, ±10%, 1W, Part of L7		
R13	Resistor: fixed, composition, 270 ohms, ±10%, 1W	24-270	B GB 2711
R14	Resistor: fixed, composition, 82,000 ohms, ±10%, 1W	24-82K	B GB 8231
R15	Resistor: fixed, composition, 330 ohms, ±10%, 1/2W	23-330	B EB 3311

*See "List of Manufacturers Code Letters For Replaceable Parts Table."

608A 2/6/53 Serial 1098 to

TABLE OF REPLACEABLE PARTS

Circuit Ref.	Description	-hp- Stock No.	Mfr. * & Mfrs. Designation
R16	Resistor: fixed, composition, 100,000 ohms, $\pm 10\%$, 1/2W	23-100K	B EB 1041
R17	Resistor: fixed, composition, 3900 ohms, $\pm 10\%$, 1W	24-3900	B GB 3921
R18	Resistor: fixed, composition, 120,000 ohms, $\pm 10\%$, 1W	24-120K	B GB 1241
R19	Resistor: fixed, composition, 100,000 ohms, $\pm 10\%$, 1W	24-100K	B GB 1041
R20	Resistor: variable, composition, 25,000 ohms, linear taper	210-11	G BAI-010-1990
R21	This circuit reference not assigned		
R22	Resistor: fixed, composition, 2700 ohms, $\pm 10\%$, 1W	24-2700	B GB 2721
R23	Resistor: fixed, composition, 100,000 ohms, $\pm 10\%$, 1/2W	23-100K	B EB 1041
R24	Resistor: fixed, composition, 10,000 ohms, $\pm 10\%$, 1W	24-10K	B GB 1031
R25	Resistor: variable, composition, 25,000 ohms, linear taper	210-11	G BAI-010-1990
R26	Resistor: fixed, composition, 100,000 ohms, $\pm 10\%$, 1W	24-100K	B GB 1041
R27	Resistor: fixed, composition, 220 ohms, $\pm 10\%$, 1W	24-220	B GB 2211
R28	This circuit reference not assigned.		
R29	Resistor: fixed, composition, 1.8 megohms, $\pm 10\%$, 1W	24-1.8M	B GB 1851
R30	Resistor: fixed, composition, 470,000 ohms, $\pm 10\%$, 1W	24-470K	B GB 4741
R31	Resistor: fixed, composition, 330,000 ohms, $\pm 10\%$, 2W	25-330K	B HB 3341

*See "List of Manufacturers Code Letters For Replaceable Parts Table."

608A 2/6/53 Serial 1098 to

TABLE OF REPLACEABLE PARTS

Circuit Ref.	Description	-hp- Stock No.	Mfr. * & Mfrs. Designation
R32	Resistor: variable, composition, 25,000 ohms, linear taper	210-11	G BAI-010-1990
R33	Resistor: fixed, composition, 270,000 ohms, $\pm 10\%$, 1W	24-270K	B GB 2741
R34	Resistor: fixed, composition, 68,000 ohms, $\pm 10\%$, 1W	24-68K	B GB 6831
R35	Resistor: fixed, composition, 27,000 ohms, $\pm 10\%$, 2W	25-27K	B HB 2731
R36	Resistor: fixed, composition, 18 ohms, $\pm 10\%$, 1W	24-18	B GB 1801
R37	This circuit reference not assigned		
R38	This circuit reference not assigned		
R39A, B	Resistor: variable, composition, (A) 50,000 (B) 2,000 ohms, linear taper	210-71	I CM 8741
R40	Resistor: fixed, composition, 71,000 ohms, $\pm 1\%$, 1/2W	33-71K	GG Type CP-1/2
R41	Resistor: fixed, composition, 28,400 ohms, $\pm 1\%$, 1/2W	33-28.4K	GG Type CP-1/2
R42	Resistor: fixed, composition, 220,000 ohms, $\pm 10\%$, 1W	24-220K	B GB 2241
R43	Resistor: fixed, composition, 6800 ohms, $\pm 10\%$, 2W	25-6800	B HB 6821
R44	Resistor: fixed, composition, 6800 ohms, $\pm 10\%$, 2W	25-6800	B HB 6821
R45	Resistor: fixed, composition, 47,000 ohms, $\pm 10\%$, 1W	24-47K	B GB 4731
R46	Resistor: fixed, composition, 71,000 ohms, $\pm 1\%$, 1/2W	33-71K	GG Type CP-1/2
R47	Resistor: fixed, composition, 28,400 ohms, $\pm 1\%$, 1/2W	33-28.4K	GG Type CP-1/2

*See "List of Manufacturers Code Letters For Replaceable Parts Table."

.608A, 2/6/53 Serial 1098 to

TABLE OF REPLACEABLE PARTS

Circuit Ref.	Description	-hp- Stock No.	Mfr. * & Mfrs. Designation
R48	Resistor: fixed, composition, 2700 ohms, $\pm 10\%$, 1W	24-2700	B GB 2721
R49	Resistor: variable, wirewound, 1000 ohms, linear taper	210-5	G 21-010-355
R50	Resistor: fixed, composition, 1 megohm, $\pm 10\%$, 1/2W	23-1M	B EB 1051
R51	Resistor: fixed, composition, 560 ohms, $\pm 10\%$, 1W	24-560	B GB 5611
R52	Resistor: variable, composition, 25,000 ohms, $\pm 10\%$, linear taper	210-54	B
R53	Lamp: 3W, 120V	211-4	O
R54	This circuit reference not assigned		
R55	Resistor: fixed, composition, 330 ohms, $\pm 10\%$, 1/2W	23-330	B EB 3311
R56	Resistor: fixed, composition, 2200 ohms, $\pm 10\%$, 2W	25-2200	B HB 2221
R57	Resistor: fixed, composition, 680 ohms, $\pm 10\%$, 1/2W	23-680	B EB 6811
R58	Resistor: fixed, composition, 1000 ohms, $\pm 10\%$, 2W	25-1000	B HB 1021
R59	Resistor: fixed, composition, 680 ohms, $\pm 10\%$, 1W	24-680	B GB 6811
R60	Resistor: fixed, composition, 1500 ohms, $\pm 10\%$, 2W	25-1500	B HB 1521
R61	Resistor: fixed, composition, 820 ohms, $\pm 10\%$, 1W	24-820	B GB 8211
R62	Resistor: fixed, wirewound, 7500 ohms, $\pm 10\%$, 10W	26-9	S Type 1-3/4E
C1	Capacitor: Part of Generator Assembly		

*See "List of Manufacturers Code Letters For Replaceable Parts Table."

608A 2/6/53 Serial 1098 to

TABLE OF REPLACEABLE PARTS

Circuit Ref.	Description	-hp- Stock No.	Mfr. * & Mfrs. Designation
C2	Capacitor: fixed, mica, 100 μf , $\pm 10\%$, 500 vdcw	15-45	L #370CH
C3	Capacitor: variable, glass, .3 - 3 μf	13-3	Corning Glass Works
C4	Capacitor: fixed, mica, 100 μf , $\pm 10\%$, 500 vdcw	15-45	L #370CH
C5	Capacitor: Part of Generator Assembly		
C6	Capacitor: fixed, 60 μf Part of Generator Assembly		
C7	Capacitor: fixed, mica, 100 μf , $\pm 10\%$, 500 vdcw	15-45	L #370CH
C8	Capacitor: fixed, oil filled paper, 1 μf , $\pm 10\%$, 600 vdcw	17-12	N 23F467G103
C9	Capacitor: fixed, oil filled paper, 1 μf , $\pm 10\%$, 600 vdcw	17-12	N 23F467G103
C10	Capacitor: fixed, paper, .5 μf , 200 vdcw	16-37	CC #68P25
C11	Capacitor: fixed, paper, 1 μf , $\pm 20\%$, 400 vdcw	16-44	A Type P482
C12	Capacitor: fixed, paper, 1 μf , $\pm 20\%$, 400 vdcw Consists of two stock #16-44 in parallel	16-44	A Type P482
C13	Capacitor: fixed, oil filled paper, 1 μf , $\pm 10\%$, 600 vdcw	17-12	N 23F467G103
C14	Capacitor: fixed, paper, 4 μf , $\pm 10\%$, 1000 vdcw	17-17	N 22F14
C15	Capacitor: fixed, paper, 4 μf , $\pm 10\%$, 1000 vdcw	17-17	N 22F14
C16	Capacitor: fixed, electrolytic, 20, 20, 40 μf , 450 vdcw	18-42S	CC #D16651
C17	Capacitor: fixed, paper, .1 μf , 400 vdcw	16-35	CC 68P10404

*See "List of Manufacturers Code Letters For Replaceable Parts Table."

608A 2/6/53 Serial 1098 to

TABLE OF REPLACEABLE PARTS

Circuit Ref.	Description	-hp- Stock No.	Mfr. * & Mfrs. Designation
C18 ABCD	Capacitor: fixed, electrolytic, 20, 20, 20, 20 μ f, 450 vdcw	18-42S	CC #D76651
C19	Capacitor: fixed, mica, 5600 μ f, \pm 1%, 300 vdcw	15-42	A, Char. E Type 1464X
C20	Capacitor: fixed, paper, 2000 μ f, -25%, +50%, 600 vdcw	16-22	A Type 684
C21	Capacitor: fixed, paper, .25 μ f, 600 vdcw	16-42	CC #68P37
C22	Capacitor: fixed, mica, 5600 μ f, \pm 1%, 300 vdcw	15-42	A, Char. E Type 1464X
C23	Capacitor: fixed, mica, 1000 μ f, \pm 25%, 500 vdcw	15-21	K Type CP-123
C24	Capacitor: fixed, mica, 1000 μ f, \pm 25%, 500 vdcw	15-21	K Type CP-123
C25	Capacitor: fixed, paper, 1 μ f, \pm 10%, 600 vdcw	17-12	N 23F467G103
CR1	Crystal Rectifier: G7	212-G7	N
CR2	Crystal Rectifier: IN34A	G-11G	EE, IN34A
E1	RF Filter: Heater Circuit	608A-27A	HP
E2	RF Filter:	608A-27D	HP
E3	RF Filter: Monitor	608A-27B	HP
E4	RF Filter: Modulator	608A-27C	HP
F1	Fuse: 3A, 3AG type	211-3	T, #1043
F2	Fuse: 1/16A, 3AG type	211-41	T, #312-062
	Fuseholder:	312-8	T, #342001
L1	RF Filter coil: 30 uh	608A-60K	HP
L2	This circuit reference not assigned		
L3, L4, R5, R6	Choke coil:	608A-60R	HP
L5	This circuit reference not assigned		
L6	Choke coil:		HP
L7, R12	Coil: .160 mh (wound on R12)	608A-60J	HP
L8	Reactor: 6H @ 125 MA, 240 ohms	911-4	HP
L9	Reactor: 6H @ 70 MA	911-35	HP

*See "List of Manufacturers Code Letters For Replaceable Parts Table."

TABLE OF REPLACEABLE PARTS

Circuit Ref.	Description	-hp- Stock No.	Mfr. * & Mfrs. Designation
M1	Meter:	112-28	HP
M2	Meter:	112-27	HP
P1	Power Cable:	M-72	HP
S1	Switch: toggle	310-11	D, 20994-HW
S2 abcd	Switch: rotary (rear switch)	310-82	HP
	Switch: rotary (mounted on panel)	310-85	HP
T1	Transformer: power	910-66	HP
T2	Transformer: power	910-88	HP
Y1	Rectifier:	212-60	M, #402D3452A
	Lamp:	211-47	O
	Knob: 1-1/2" diam.	37-11	HP
	Knob: 2" diam.	37-13	HP
	Binding Post:	312-3	HP
	Motor Base Socket:	38-52	O, #2711
	Tube clamp: small	312-61	George S. Thompson Corp., #926-B
	Tube clamp: large	312-62	George S. Thompson Corp. #926-C
	Dial Indicator: Index for atten.	G-99C	HP
	Freq. Dial Indicator:	608A-99A	HP
	Freq. Control Knob:	608A-74B	HP
	Freq. Vernier Dial:	6A-40C	HP
	Type N Jack Assembly:		
	Contact:	38-80	HP
	Panel Jack:	G-76A	HP
Nut:	G-57D	HP	
Bead:	G-76A-2	HP	
Bushing:	G-76A-1	HP	
Bead:	G-76A-3	HP	
Spacer:	G-76A-4	HP	
Type BNC Panel Jack:	38-71	Q, UG291/U	

*See "List of Manufacturers Code Letters For Replaceable Parts Table."

608A 2/6/53 Serial 1098 to

TABLE OF REPLACEABLE PARTS

Circuit Ref.	Description	-hp- Stock No.	Mfr. * & Mfrs. Designation
V1	Tube: 5893 or 5675	212-72 212-5675	Y ZZ
V2	Tube: 5876	212-5876	Y
V3	Tube: 6L6	212-6L6	ZZ
V4	Tube: 6L6	212-6L6	ZZ
V5	Tube: 6AC7	212-6AC7	ZZ
V6	Tube: 5U4G	212-5U4G	ZZ
V7	Tube: 6AS7G	212-6AS7G	ZZ
V8	Tube: 6AC7	212-6AC7	ZZ
V9	Tube: 6H6	212-6H6	ZZ
V10	Tube: 6SJ7	212-6SJ7	ZZ
V11	Tube: VR75	212-VR75	ZZ
V12	Tube: 6SN7	212-6SN7	ZZ

*See "List of Manufacturers Code Letters For Replaceable Parts Table."

608A 2/6/53 Serial 1098 to

CLAIM FOR DAMAGE IN SHIPMENT

The instrument should be tested as soon as it is received. If it fails to operate properly, or is damaged in any way, a claim should be filed with the carrier. A full report of the damage should be obtained by the claim agent, and this report should be forwarded to us. We will then advise you of the disposition to be made of the equipment and arrange for repair or replacement. Include model number, type number and serial number when referring to this instrument for any reason.

WARRANTY

Hewlett-Packard Company warrants each instrument manufactured by them to be free from defects in material and workmanship. Our liability under this warranty is limited to servicing or adjusting any instrument returned to the factory for that purpose and to replace any defective parts thereof (except tubes, fuses and batteries). This warranty is effective for one year after delivery to the original purchaser when the instrument is returned, transportation charges prepaid by the original purchaser, and which upon our examination is disclosed to our satisfaction to be defective. If the fault has been caused by misuse or abnormal conditions of operation, repairs will be billed at cost. In this case, an estimate will be submitted before the work is started.

If any fault develops, the following steps should be taken:

1. Notify us, giving full details of the difficulty, and include the model number, type number and serial number. On receipt of this information, we will give you service instruction or shipping data.
2. On receipt of shipping instruction, forward the instrument prepaid, and repairs will be made at the factory. If requested, an estimate of the charges will be made before the work begins provided the instrument is not covered by the warranty.

SHIPPING

All shipments of Hewlett-Packard instruments should be made via Railway Express. The instruments should be packed in a wooden box and surrounded by two to three inches of excelsior or similar shock-absorbing material.

DO NOT HESITATE TO CALL ON US

HEWLETT-PACKARD COMPANY

Laboratory Instruments for Speed and Accuracy

395 PAGE MILL ROAD



PALO ALTO, CALIFORNIA

LIST OF MANUFACTURERS CODE LETTERS
FOR REPLACEABLE PARTS TABLE

<u>Code Letter</u>	<u>Manufacturer</u>
A	Aerovox Corp.
B	Allen-Bradley Co.
C	Amperite Co.
D	Arrow, Hart and Hegeman
E	Bussman Manufacturing Co.
F	Carborundum Co.
G	Centralab
H	Cinch Manufacturing Co.
I	Clarostat Manufacturing Co.
J	Cornell Dubilier Electric Co.
K	Electrical Reactance Co.
L	Erie Resistor Corp.
M	Federal Telephone and Radio Corp.
N	General Electric Co.
O	General Electric Supply Corp.
P	Girard-Hopkins
HP	Hewlett-Packard
Q	Industrial Products Co.
R	International Resistance Co.
S	Lectrohm, Inc.
T	Littelfuse, Inc.
U	Maguire Industries, Inc.
V	Micamold Radio Corp.
W	Oak Mfg. Co.
X	P. R. Mallory Co., Inc.
Y	Radio Corp. of America
Z	Sangamo Electric Co.
AA	Sarkes Tarzian
BB	Signal Indicator Co.
CC	Sprague Electric Co.
DD	Stackpole Carbon Co.
EE	Sylvania Electric Products, Inc.
FF	Western Electric Co.
GG	Wilkor Products, Inc.
HH	Amphenol
II	Dial Light Co. of America
JJ	Leecraft Manufacturing Co.
ZZ	Any tube having RMA standard characteristics